



NANYANG PRIMARY SCHOOL

PRIMARY 4 SCIENCE

**SEMESTRAL ASSESSMENT 2
2015**

BOOKLET A

Date : 27 October 2015

Duration : 1 h 45 min

Name : _____ ()

Class: Primary 4 ()

**DO NOT OPEN THIS BOOKLET UNTIL YOU ARE TOLD TO DO SO.
FOLLOW ALL INSTRUCTIONS CAREFULLY.**

Booklet A consists of 20 printed pages including this cover page.

Section A (30 x 2 marks = 60 marks)

For each question from 1 to 30, four options are given. One of them is the correct answer. Make your choice (1, 2, 3 or 4). Shade the correct oval (1, 2, 3 or 4) on the Optical Answer Sheet provided.

1. Which one of the following is a living thing?

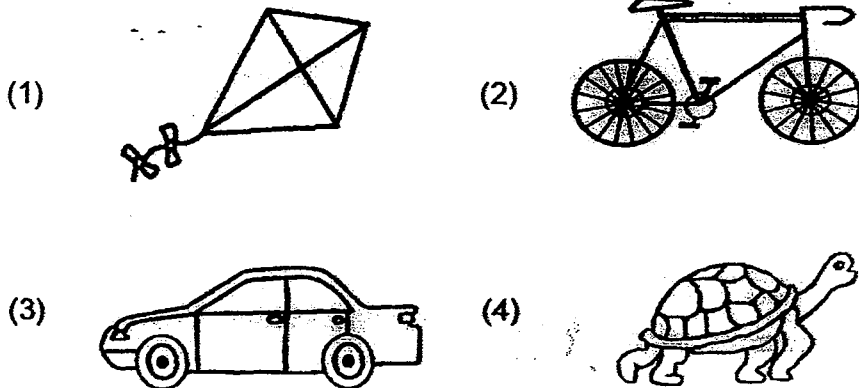

2. Study the chart below.

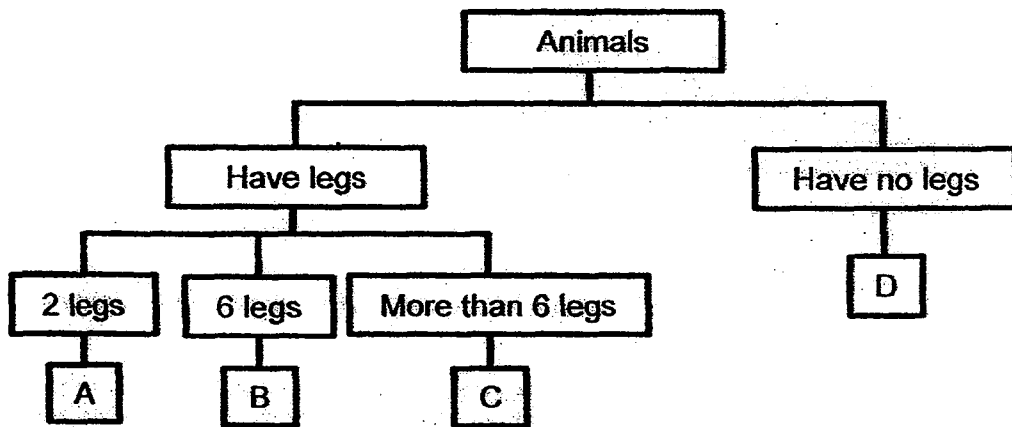

Where would you put this animal in the chart above?

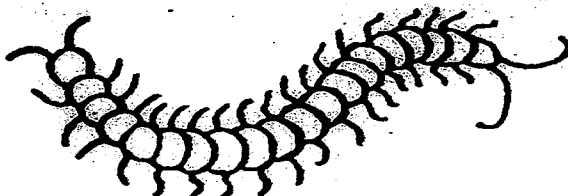

- (1) A (2) B
 (3) C (4) D

3. The diagram below shows the growth of a young plant with two missing stages P and Q.

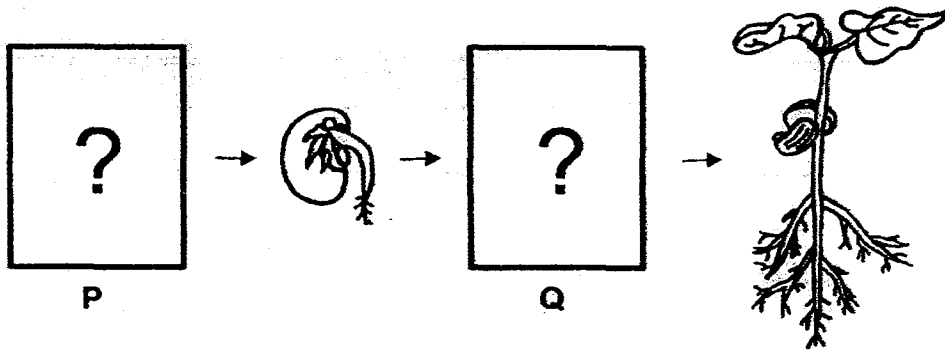

Which one of the following shows the correct stages for P and Q?

	P	Q
(1)		
(2)		
(3)		
(4)		

4. The diagram below shows a young plant.

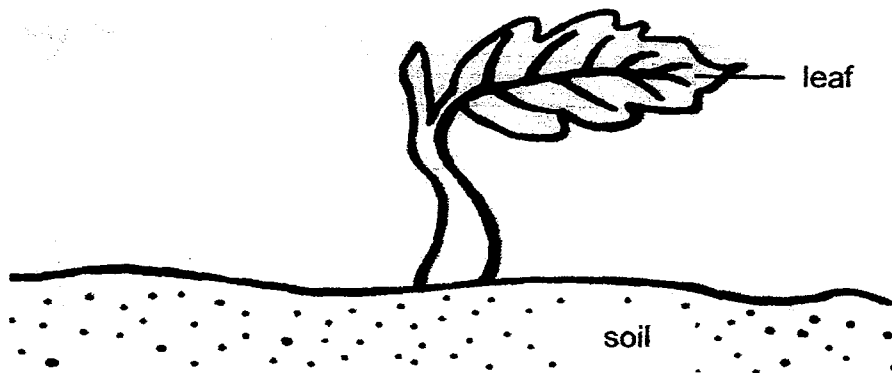

The leaf helps the plant to _____.

- (1) make food
 - (2) grow upright
 - (3) absorb water
 - (4) absorb nutrients
5. In which part of the digestive system is food absorbed into the blood?
- (1) gullet
 - (2) stomach
 - (3) large intestine
 - (4) small intestine
6. Azman put a solid metal block into a container of water. At which position, A, B, C or D, would the block most likely be found?

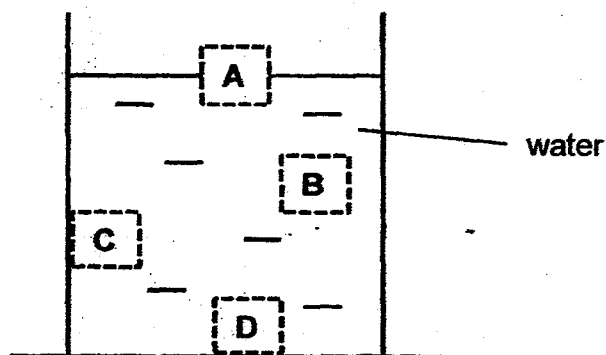

- (1) A
- (2) B
- (3) C
- (4) D

7. In which one of the following diagrams will the two magnets push each other away?

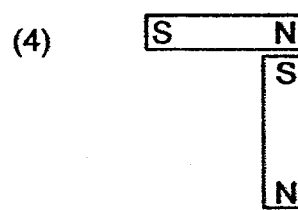
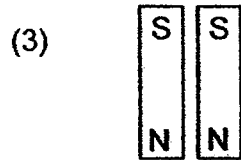
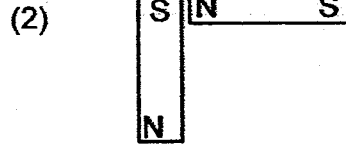
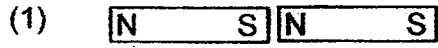

8. Look at the picture below.

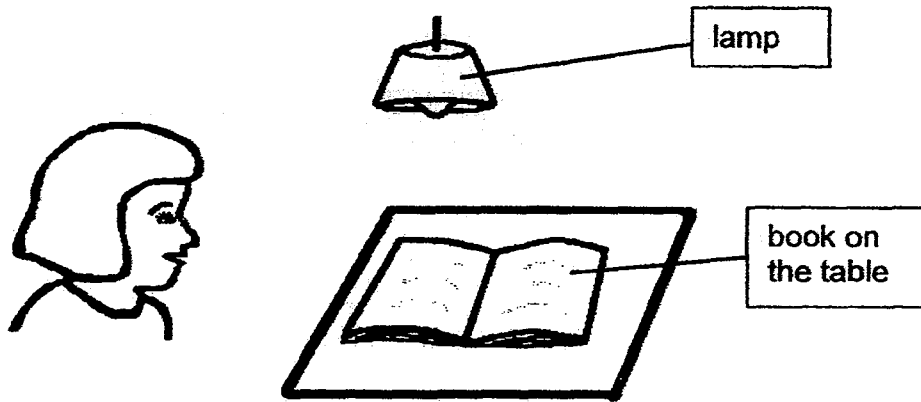

Which one of the following explains why Mei Li can see the book on the table?

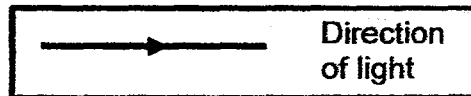

(1)	<p>A diagram showing the person looking at the book. An arrow points from the book to the person's eye. The lamp is above the book.</p>	(2)	<p>A diagram showing the person looking at the book. An arrow points from the lamp down to the book, and another arrow points from the book to the person's eye.</p>
(3)	<p>A diagram showing the person looking at the book. An arrow points from the lamp down to the person's eye. The book is on the table.</p>	(4)	<p>A diagram showing the person looking at the book. An arrow points from the lamp down to the book. The person's eye is not connected to any light rays.</p>

9. Which one of the following properties is true for both air and a pencil?

- (1) They can be seen.
- (2) They take up space.
- (3) They have definite shapes.
- (4) They have definite volumes.

10. Mathew wants to measure the temperature of hot water in a beaker.

Which one of the following diagrams shows the correct position of the thermometer when taking the temperature reading?

(1)

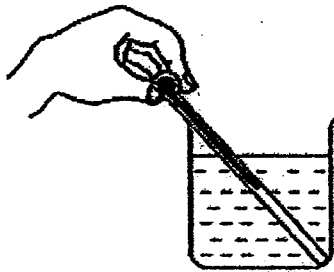

(2)

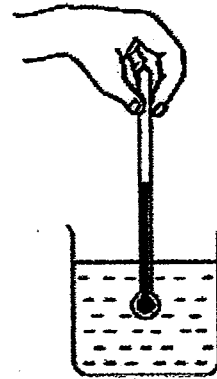

(3)

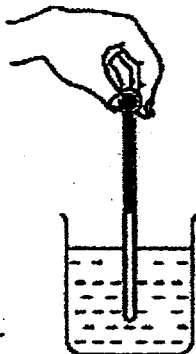

(4)

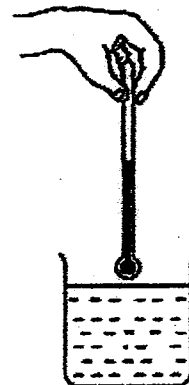

11. Ali placed a pot of plant in a room and the only light source was from the window as shown below.

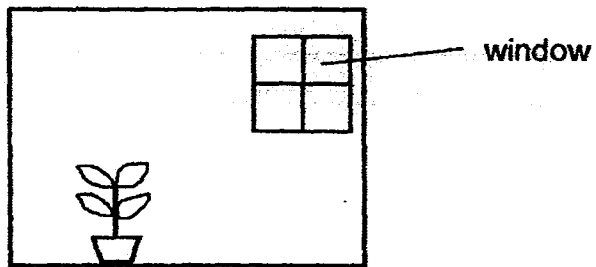

He then covered the plant in a box that had a small opening. After 1 week, the plant looked like this.

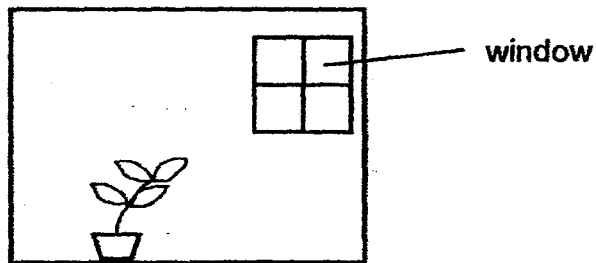

Which box had he used to cover the plant for 1 week?



metal box



wooden box

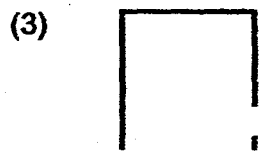

cardboard box



glass box

12. Baba observed P and Q for a week and recorded their height in the graphs as shown below.

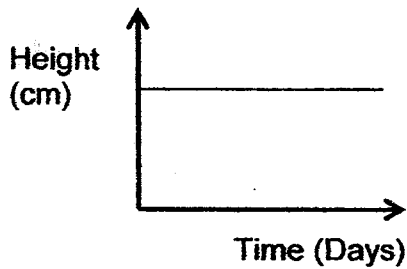

P

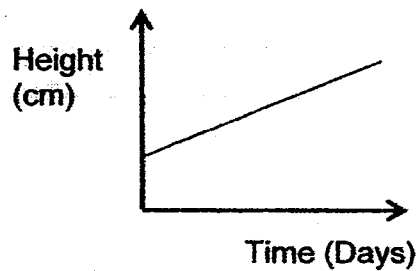

Q

Based only on the graphs above, what is/are the possible conclusion(s) Baba could make about P and Q?

- A Q is a living thing.
- B Q grows more healthily than P.
- C P does not need air, food and water.
- D P can respond to changes around it.

- (1) A only
- (3) A and C only

- (2) D only
- (4) B and C only

13. Study the table below.

Living Things	Non-living Things
bat goldfish penguin	moss rock yeast

Which two of the above are **wrongly** grouped?

- (1) rock and bat
- (2) moss and yeast
- (3) bat and yeast
- (4) rock and moss

14. Elsa observed an animal in her garden and wrote down the following observations.

- It can swim.
- It has four legs.
- It has a hard shell.
- It does not have hair.

Based on the observations above, she made the following conclusions.

- A Only animals with no hair can lay eggs.
- B It can swim so it must be an amphibian.
- C It is a reptile because only reptiles have four legs..
- D It is an insect because it has a hard outer covering..

Which statement(s) is/are wrong?

- (1) C only
- (2) B and D only
- (3) A, B and C only
- (4) A, B, C and D

15. Four pupils went to the garden and saw a plant in the pond. Their teacher only wanted them to record an **observation**. They studied it for a while and recorded the following statements.

- Anna : The leaves are waxy and oval in shape.
- Bala : It is a non-flowering plant because it has no flowers.
- Cola : The roots are thick and so they grow deep into the ground.
- Dora : It is not a water plant as it is floating on the water and not fully submerged.

Who had stated an observation?

- (1) Anna
- (2) Bala
- (3) Cola
- (4) Dora

16. Ferby wanted to conduct an experiment to find out if moisture was required for mould to grow.

Setups	Location	Bread
A	beside an open window	toasted
B	in the freezer	toasted
C	beside an open window	sprinkled with water
D	in the freezer	sprinkled with water

Which two of the above setups should she use?

- (1) A and B
 (2) A and C
 (3) B and C
 (4) C and D
17. Minnie cut various parts from four similar plants as shown below. Then she put each of them into a pot of soil to grow.

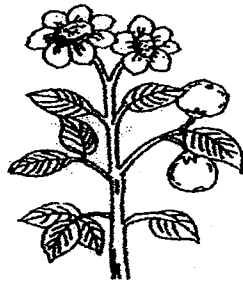

roots removed

A

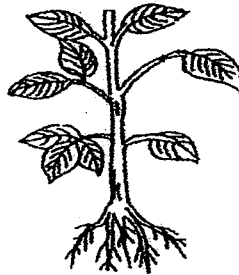

flowers and fruits removed

B



leaves, roots and flowers removed

C



roots and some leaves removed

D

Which plant is most likely to grow healthily after two weeks?

- (1) A
 (2) B
 (3) C
 (4) D

18. Which one of the following function(s) correctly matches the organ system?

	Organ System	Function
A	skeletal system	protect the heart
B	muscular system	gives the body its shape
C	respiratory system	carries only oxygen to all parts of the body
D	circulatory system	passes waste materials out of the body

- (1) A only
 (2) B only
 (3) C and D only
 (4) A, B, and D only

19. How are the life cycles of a mealworm beetle and a butterfly similar?

- A Their young resemble their adults.
 B They moult several times during the larval stage.
 C They start to fly when they are in the pupal stage.
 D The young and adult both feed on the same type of food.

- (1) B only
 (2) A and C only
 (3) C and D only
 (4) A, B and D only

20. Study the table below.

Characteristic	Organisms		
	S	T	U
Has a pupal stage	✓	x	x
Its young moults	✓	x	✓
Spends at least one stage of its life cycle in water	✓	✓	x

Based on the information above, which of the following statements are true about organisms S, T and U?

- A S can be a mosquito.
 B U lays its eggs in water.
 C T is definitely an insect.
 D S has four stages in its life cycle.

- (1) A and B only
 (2) A and D only
 (3) B and C only
 (4) C and D only

21. Ahmad cut out a rectangle and a diamond from 2 identical cardboard sheets as shown below. The two sheets are of the same size.

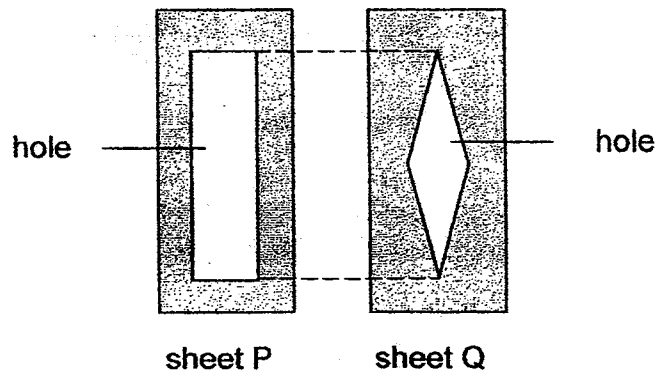

Front view of cardboard sheets

The 2 cardboard sheets, P and Q, were placed together in a straight line between the screen and the torch as shown below.

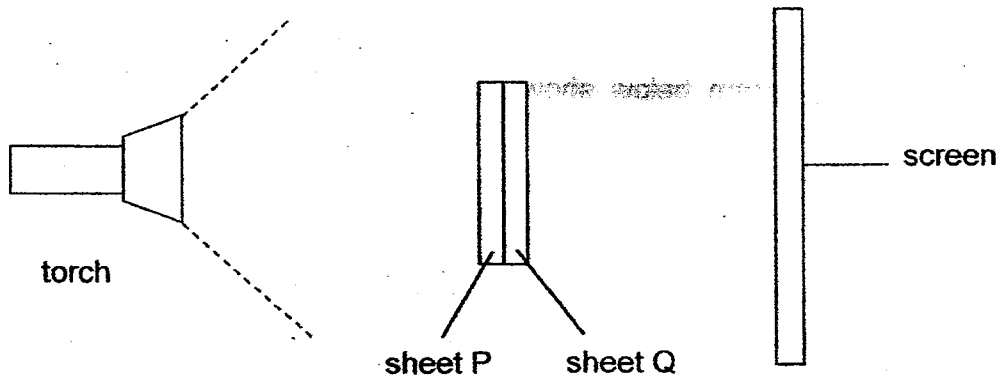

Which one of the following could most likely be the shadow cast on the screen?

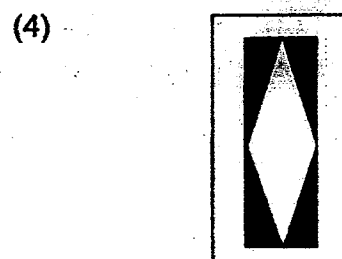
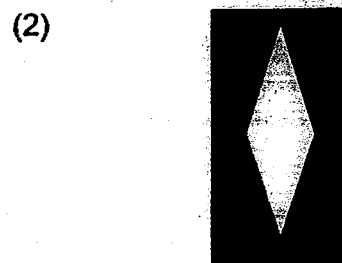
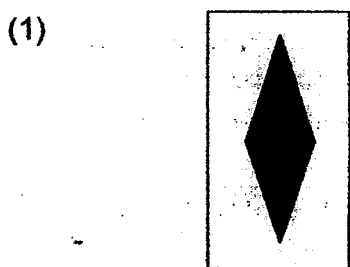

22. Kai Pin used a hollow rubber tube to look at a lighted candle.

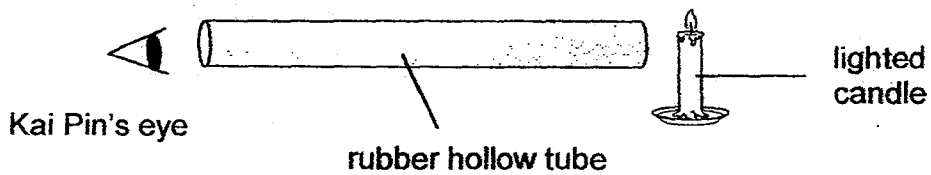

Which of the following statements explained why Kai Pin was able to see the lighted candle at the end of the hollow rubber tube?

- A Light is entering his eyes.
- B Light travels in a straight line.
- C Light is given out by the lighted candle.
- D Light cannot pass through the rubber hollow tube.

- (1) A and B only
- (2) C and D only
- (3) A, B and C only
- (4) B, C and D only

23. The diagram below shows a beaker of boiling water with some ice cubes.

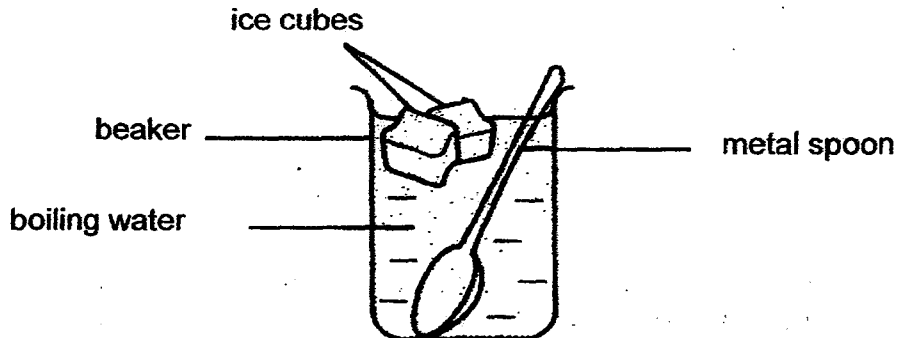

The metal spoon was placed into the beaker. Which one of the following correctly shows whether heat is gained or lost by the ice cubes, boiling water and metal spoon during the next five minutes?

	ice cubes	boiling water	metal spoon
(1)	lose heat	gain heat	lose heat
(2)	gain heat	lose heat	gain heat
(3)	lose heat	lose heat	gain heat
(4)	gain heat	gain heat	lose heat

24. Zi Ying coated the same amount of wax on the ends of 3 rods made of 3 different materials, A, B and C. She also attached 3 identical pins to the wax as shown in the diagram below. She then placed them in a tank of boiling water at the same time.

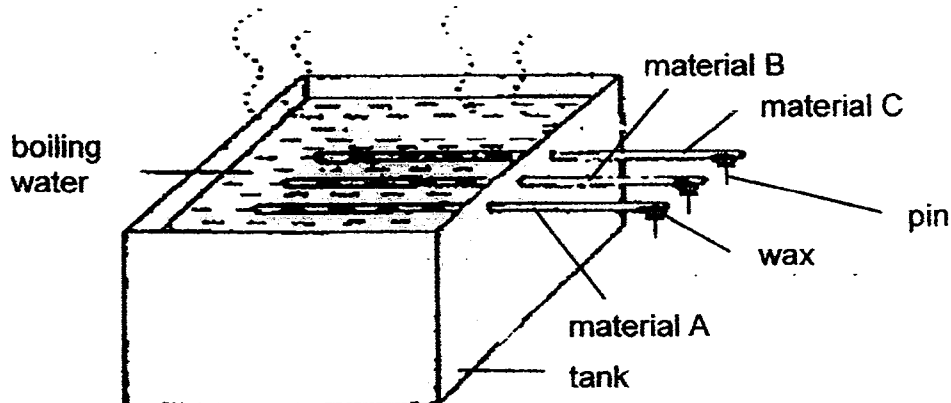

She recorded the time taken for the pins to drop in the table below.

Material	Time taken for pins to drop (min)
A	8
B	14
C	3

Based on the results above, which of the statements is/are true?

- A Material B is the best conductor of heat.
- B Material C is a better conductor of heat than material A.
- C Material A is most suitable to make into handles of cooking pots.

(1) A only

(2) B only

(3) A and C only

(4) B and C only

25. Jerry placed an empty round-bottom flask into a basin of ice cubes. The flask was fitted with a stopper where a glass tube was attached. He added a drop of ink into the glass tube. After 5 minutes, he observed that the drop of ink had moved down.

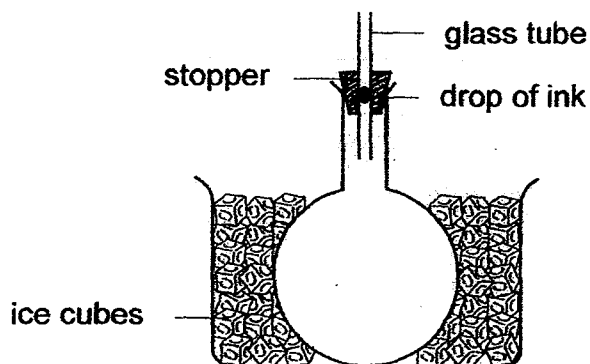

Which one of the following explains his observation?

- (1) The glass tube gained heat and expanded.
 - (2) The basin of ice cubes lost heat and contracted.
 - (3) Air in the flask lost heat to the ice cubes and contracted.
 - (4) Air in the flask gained heat from the ice cubes and expanded.
26. Study the classification table below.

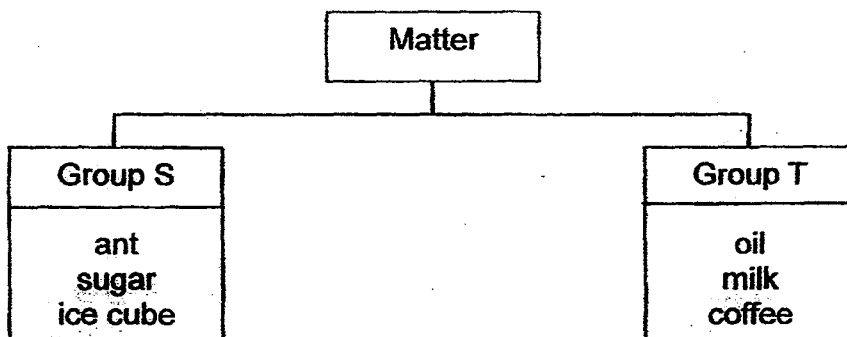

Which one of the following statements describes a common property of the items in groups S and T?

- (1) They occupy space.
- (2) They can be compressed.
- (3) They have a definite shape.
- (4) They have no definite volume.

27. Objects A, B and C are placed on two beam balances as shown below.

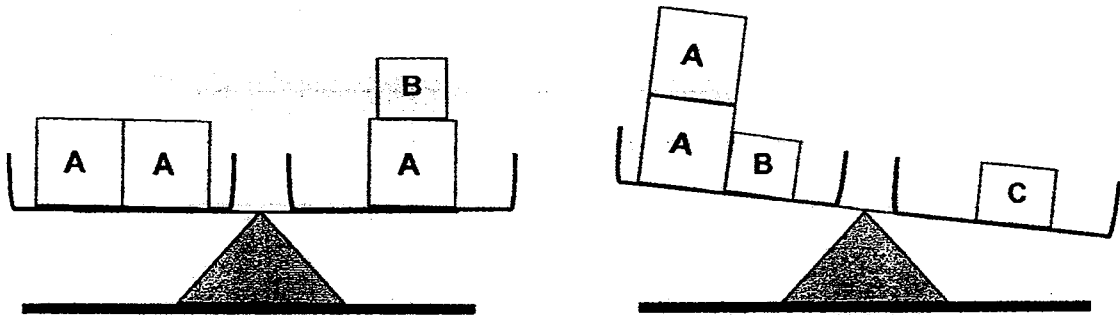

Based on the diagrams above, which one of the following conclusions can be made?

- (1) Object A has the greatest mass.
- (2) Object B has the same mass as object A.
- (3) Object B has a greater mass than object C.
- (4) Object C has the same mass as two objects A.

28. Jelly suspended 4 strips of different materials, W, X, Y and Z, from a rod as shown below.

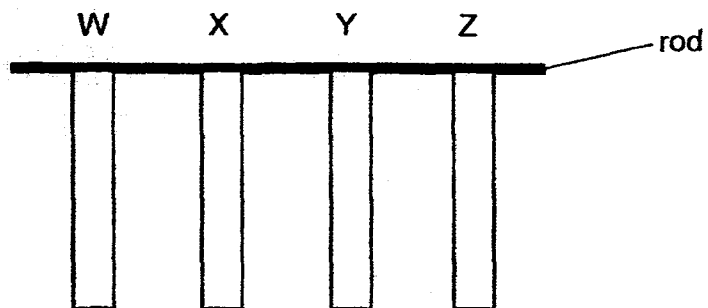

For the first experiment, she dipped them into coloured water and observed the height of coloured water absorbed by the strips.

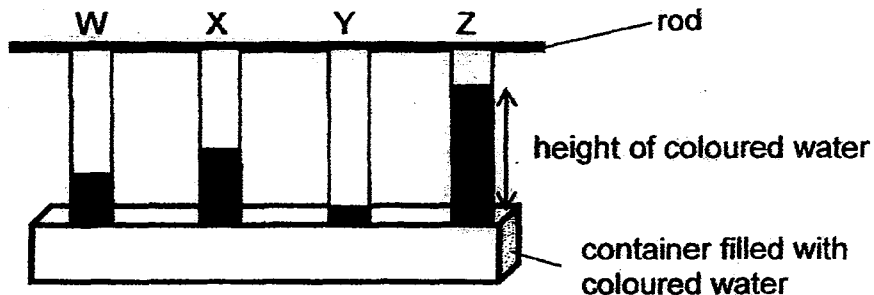

For the second experiment, she hung weights one by one at the end of each strip until it started to tear. The diagram below showed the maximum number of weights hung.

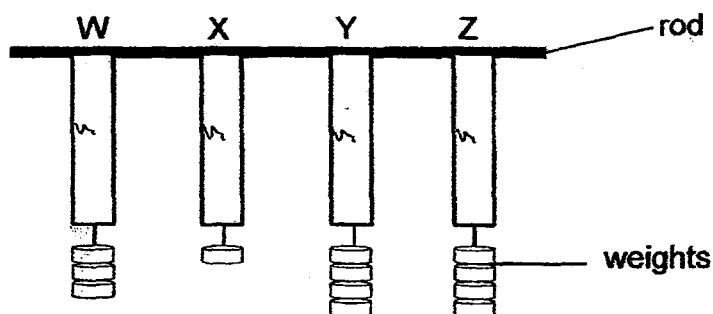

Based on her results, which material should she choose to make a school bag?

- | | |
|-------|-------|
| (1) W | (2) X |
| (3) Y | (4) Z |

29. Four objects with only one end labelled A, B, C and D were hung from a rod as shown below.

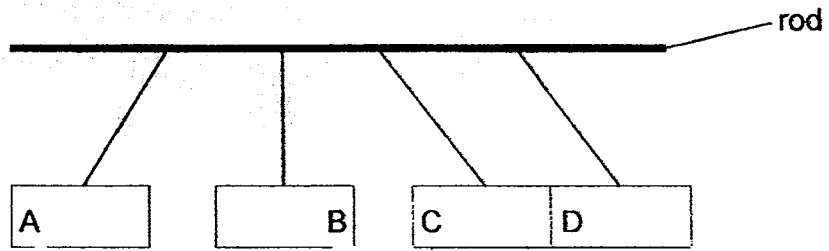

Lemmy took down all four objects and rearranged them.

Which one of the following arrangements is most likely to be correct?

(1)

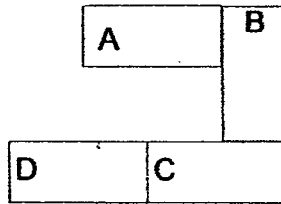

(2)

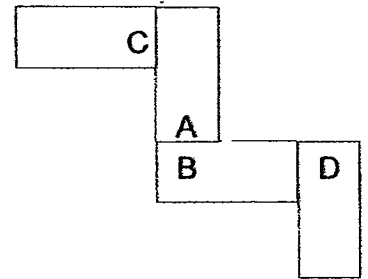

(3)

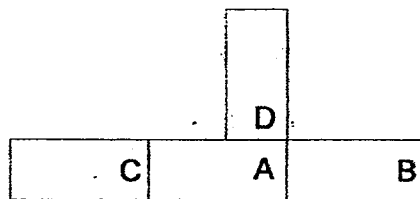

(4)

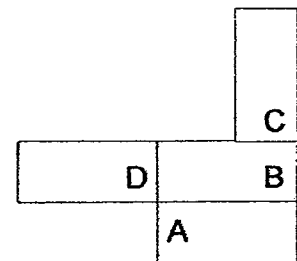

30. Mani decided to make a temporary magnet with a magnet and an iron nail, using the stroking method. Before he started, he observed that the magnet could attract 3 pins with one end of the magnet.

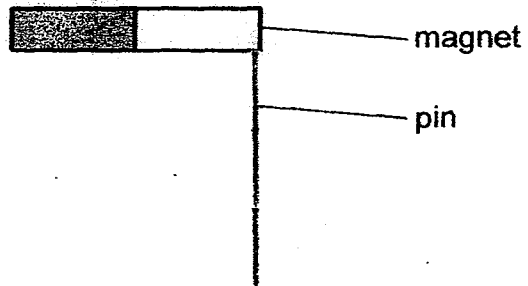

Then he began to stroke the nail with the magnet in the directions as shown in the diagram below.

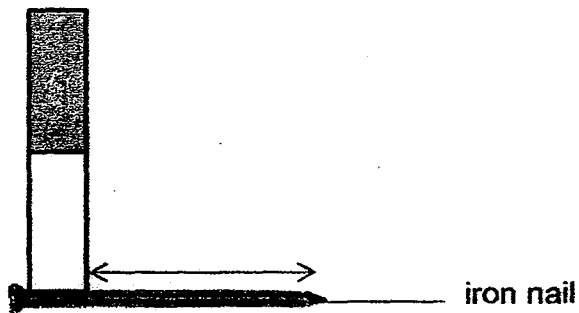

How many pins could his temporary magnet attract?

- | | | | |
|-----|---|-----|---|
| (1) | 0 | (2) | 2 |
| (3) | 3 | (4) | 5 |

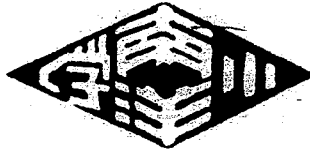

NANYANG PRIMARY SCHOOL

PRIMARY 4 SCIENCE

**SEMESTRAL ASSESSMENT 2
2015**

BOOKLET B

Date : 27 October 2015

Duration : 1 h 45 min

Name : _____ ()

Class: Primary 4 ()

Marks Scored:

Booklet A:		60
Booklet B :		40
Total :		100

Any query on marks awarded should be raised by _____. We seek your understanding in this matter as any delay in the confirmation of marks will lead to delays in the generation of results.

Parent's signature:

**DO NOT OPEN THIS BOOKLET UNTIL YOU ARE TOLD TO DO SO.
FOLLOW ALL INSTRUCTIONS CAREFULLY.**

Booklet B consists of 15 printed pages including this cover page.

Section B (40 marks)

Write your answers to questions 31 to 44 in the spaces provided.

31. Fill in the correct parts of a plant in the table. [2]

Functions of plant parts	Plant parts
It holds the plant upright.	
It obtains water for the plant.	

32.



(a) Leila places a magnet near an iron rod. The iron rod moves towards the magnet. [1]

The magnet exerts a _____ on the rod.



(b) Choose the correct word from the box to answer the question below. [1]

flexible magnetic strong

Leila's observation shows that iron is a _____ material.

33. Look at the pictures. Tick (✓) the sources of light.

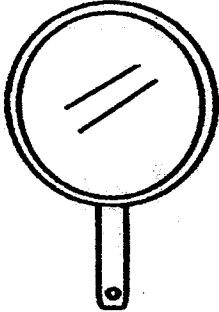
[2]

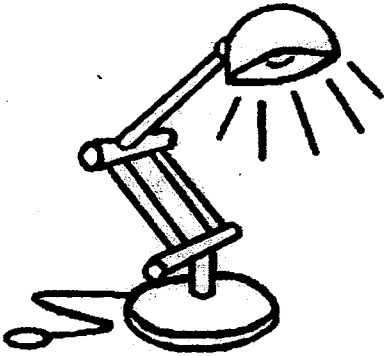
<p><input type="checkbox"/> mirror</p> 	<p><input type="checkbox"/> fire</p> 
<p><input type="checkbox"/> eyes</p> 	<p><input type="checkbox"/> lamp</p> 

34. Muthu placed a metal rod and a plastic rod into a tank of boiling water as shown below. [2]

Equal amounts of wax were placed on one end of each rod.

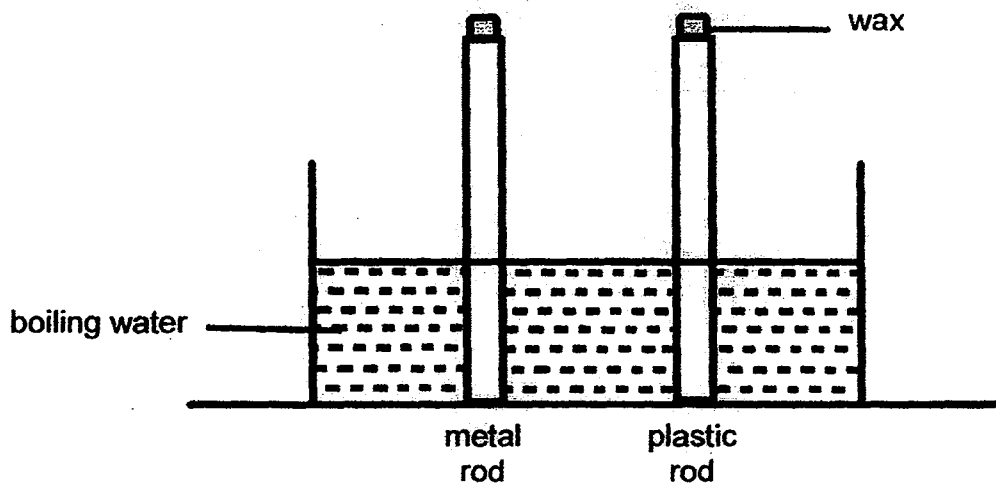

What would he observe and why?

The wax on the metal rod melted _____ than the wax on the plastic rod as metal is a _____ conductor of heat than plastic.

35. Terry compares the mass of three fruits.

[2]

Study the diagrams below and circle the correct comparison.

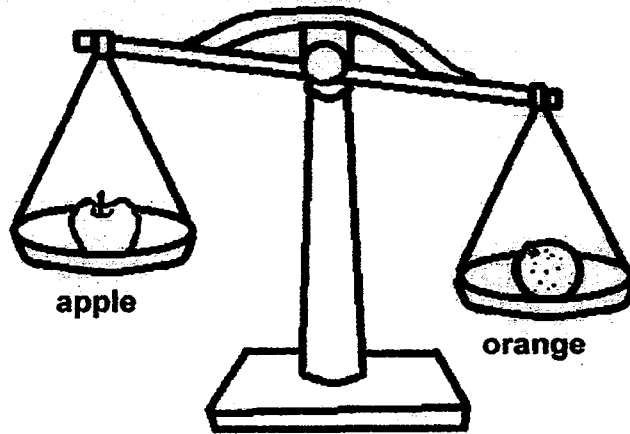

(a) The apple (is heavier than / has the same mass as / is lighter than) the orange.

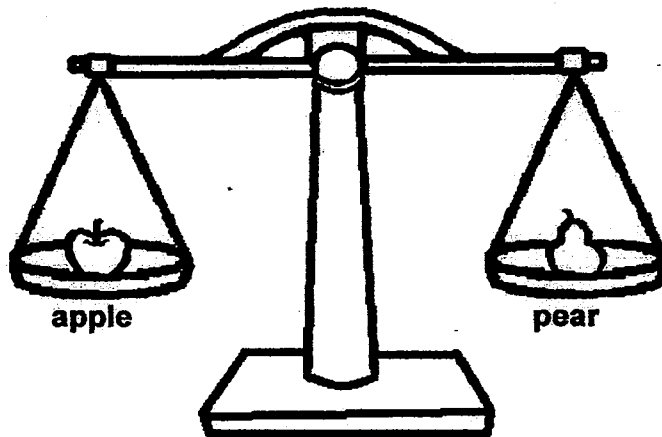

(b) The apple (is heavier than / has the same mass as / is lighter than) the pear.

36. Study the classification chart below.

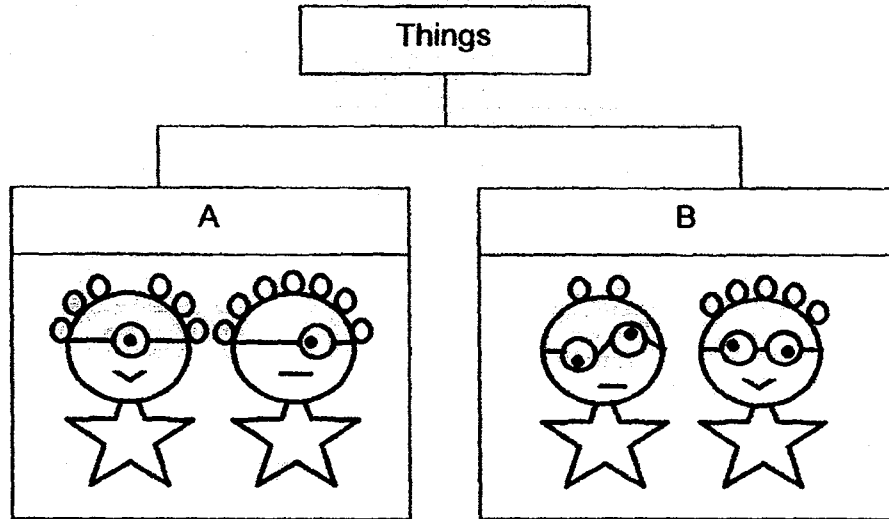

(a) Give a header for A and B. [1]

A: _____

B: _____

(b) What could Tom do to find out if the things above were living things? Give a reason for your answer. [2]

37. Study the diagram below.

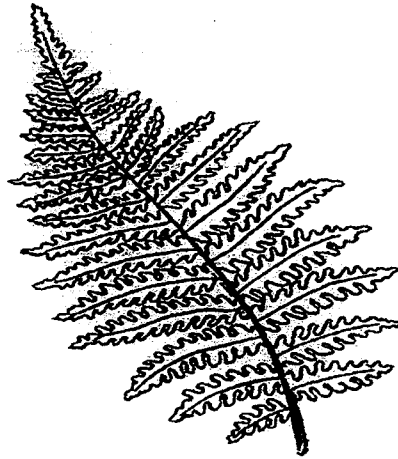

Jerry studied the leaf shown above and immediately concluded that it belonged to a non-flowering plant.

(a) What could he have observed on the leaf for him to make this conclusion? [1]

(b) Give an example of a non-flowering plant. [1]

(c) Draw the life cycle of a flowering plant in the box below [1]

38. Study the flowchart below.

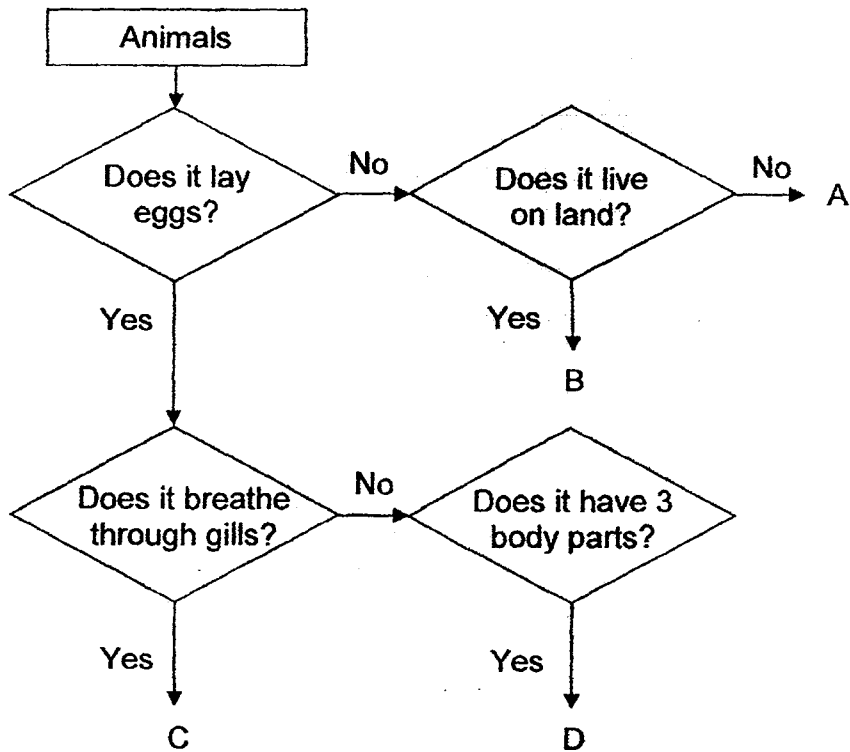

(a) Based on the flowchart, state **all** the characteristics of animal D. [1]

(b) Based on the flowchart, state a difference between animals C and D. [1]

(c) Organism X is warm-blooded and it suckles its young. It needs to rise to the water surface to breathe after several minutes.

i) Which organism A, B, C or D can represent organism X? [1]

ii) Give an example of organism X. [1]

39. Study the table below carefully.

Based on the information given, identify and match the correct letter to the animals stated in the box below. [2]

Animal	Has a 4-stage life cycle	Young resembles the adult	Adult lay eggs in water
A	Yes	No	Yes
B	No	No	Yes
C	Yes	No	No
D	No	Yes	No

frog chicken ladybird beetle mosquito

A: _____

B: _____

C: _____

D: _____

40. Study the pictures below.



egg case

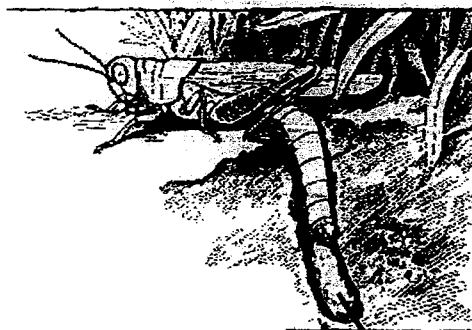

eggs

- (a) The cockroach lays its eggs in an egg case in dark places and a grasshopper lays its eggs in the soil. Explain why the female adults lay their eggs in such places. [1]

- (b) Why is it important for these insects to reproduce? [1]

The diagram below shows the life cycle of a grasshopper. Use it to answer parts (c) and (d).

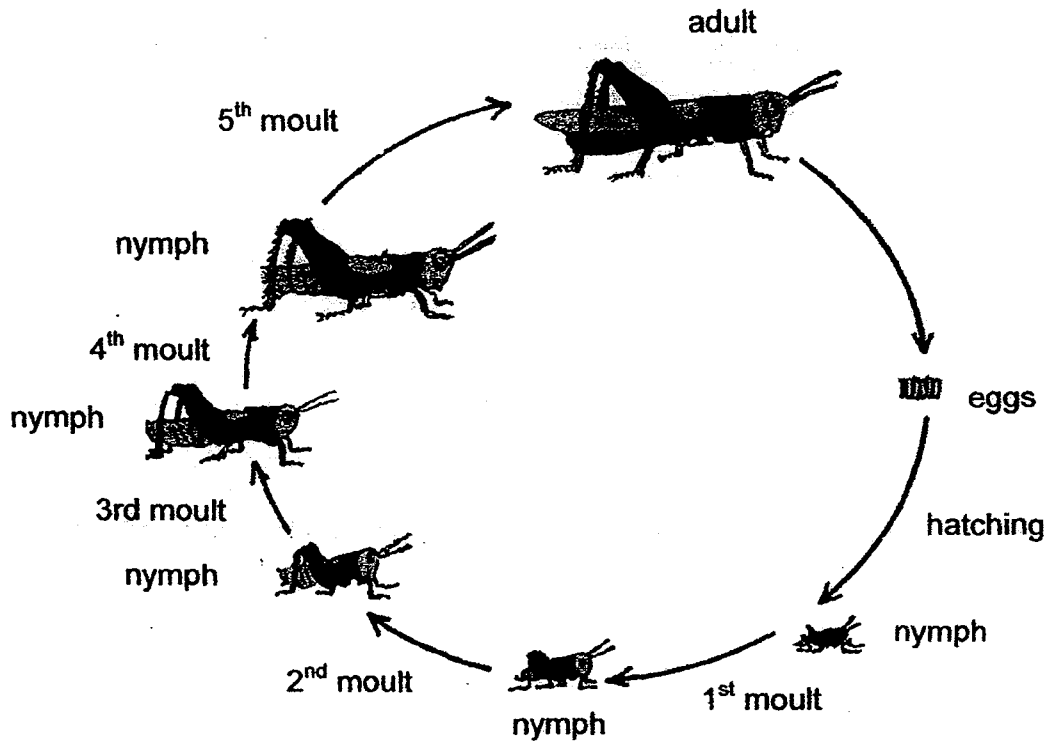

(c) Based on the diagram given, how many stages are there in the life cycle of a grasshopper? [1]

(d) What is one change that happens to the grasshopper each time it moults? [1]

41. Mickey wanted to make a magnet using the electrical method.

- (a) Other than a battery, what other items would he need? [1]
Tick the correct box(es).

magnet	<input type="checkbox"/>
steel rod	<input type="checkbox"/>
nylon string	<input type="checkbox"/>
copper wire	<input type="checkbox"/>

When he tested the electromagnet that he had made, he obtained the following results.

	Silver Pins	Steel Pins
Number of pins attracted	0	4

- (b) He re-constructed his electromagnet and tested again. The number of steel pins attracted increased. Predict the number of silver pins attracted by writing your prediction in the space provided. [1]

	Silver Pins	Steel Pins
Number of pins attracted	<u> </u>	8

- (c) Without replacing any of the items or adding new items, what had he done to the electromagnet in order to attract 8 steel pins? [1]

- (d) State one other way that he could make a stronger electromagnet. [1]

42. Donald conducted an experiment to find out how the size of the biscuits would affect the rate at which they were broken down. There were 20g of biscuits and 50ml of digestive juice in each set-up.

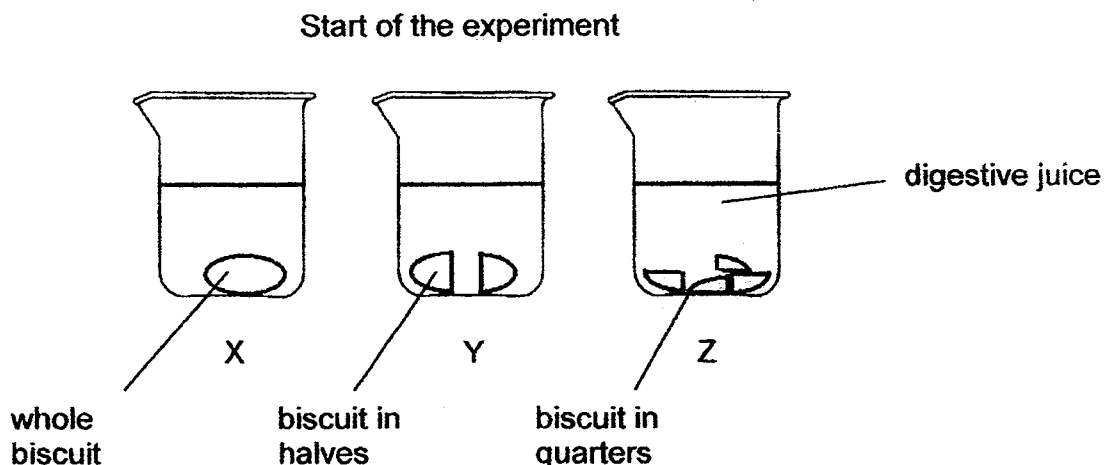

After an hour, he observed that the biscuits in set-up Z were broken down the most and the biscuit in set-up X was broken down the least.

- (a) What is the relationship between the size of the biscuit and the rate at which it is broken down? [1]

Donald was always reminded by his mother to chew his food slowly and thoroughly.

- (b) How does chewing his food thoroughly help him with the digestion of food in his stomach? [1]

- (c) Explain what happened to the food in the large intestine. [1]

43. Chloe prepared two set-ups, X and Y, as shown in the diagrams below. She placed a stopper over the mouth of plastic tube A in set-up X. She wanted to find out what would happen to the balloons when she blew into plastic tube B of both setups.

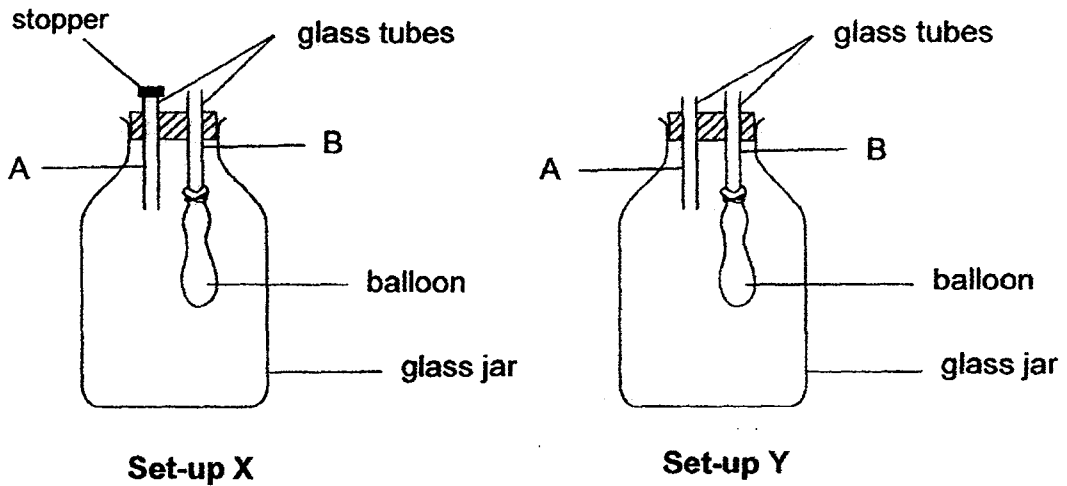

(a) What would Chloe observe about the size of the balloon in Set-up X and Y? [1]

(b) Explain your answer in (a). [2]

44. Samuel scooped some ice cream into a cup. He felt that the cup was cold to his touch.

(a) After leaving the ice cream on the dinner table for five minutes, he observed that the ice cream started to turn into a liquid.

Give a reason for his observation.

[1]

Two metal cups, P and Q, were stacked together and could not be separated. Samuel placed the cups in a basin filled with ice cubes as shown in the diagram below. He realised that the cups still remained stuck together. His mother suggested that he should also use hot water.

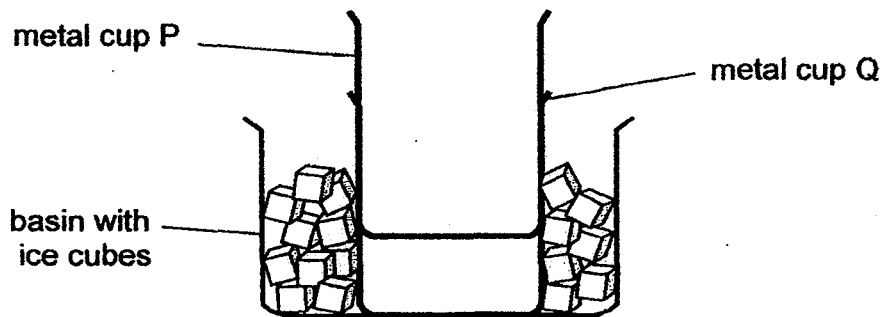

(b) Using both the ice cubes and hot water, what could Samuel do to separate the two metal cups?

[1]

(c) Explain your answer in (b).

[2]

END



EXAM PAPER 2015**LEVEL : PRIMARY 4****SCHOOL : NANYANG PRIMARY SCHOOL****SUBJECT : SCIENCE****TERM : SA2**

Q 1	Q 2	Q 3	Q 4	Q 5	Q 6	Q 7	Q 8	Q 9	Q 10
4	3	4	1	4	4	3	3	2	2
Q 11	Q 12	Q 13	Q 14	Q 15	Q 16	Q 17	Q 18	Q 19	Q 20
4	1	2	4	1	2	2	1	1	2
Q21	Q22	Q23	Q24	Q25	Q26	Q27	Q28	Q29	Q30
2	3	2	2	3	1	2	3	3	1

Q31. Stem / roots

Q32a attraction

Q32b magnetic

Q33 fire / lamp

Q34 faster / better

Q35a. is lighter than

Q35b has the same mass

Q36a. A: one - eyed doll

Q36a. B: Two - eyed doll

Q36b. He can touch or poke them to see if they respond. Living things can respond to changes.

Q37a. He observed spores under the leaves.

Q37b. Bird-nest fern

Q37c. seed → young plant → adult plant

Q38a. It lays eggs, it does not breath through gills and it has 3 body parts.

Q38b. Animal C breathes through gills while animal D does not breathe through gills.

Q38c. (i) Organism A

Q38c (ii) Dolphin

Q39. A: mosquito B: frog C: ladybird beetle D: Chicken

Q40a. They want to protect their eggs from predators.

Q40b. It is important for these insects to reproduce to make sure its species does not go extinct.

Q40c. 3 stages.

Q40d. It becomes bigger each time.

Q41a. steel rod / copper wire

Q41b. silver pins - 0

Q41c. He increased the number of coils around the rod.

Q41d. Add more batteries.

Q42a. The smaller the size of the biscuit, the faster it is broken down into.

Q42b. Chew food breaks it into smaller pieces for digestion to take place faster.

Q42c. Water is removed from the undigested food in the large intestine.

Q43a. The balloon in Y would be bigger than the balloon in x.

Q43b. Air occupies space. In set up A, there is a stopper so air blown into B cannot occupy the space inside the glass jar as air inside cannot escape. In set up Y, air inside can escape and allow space for the balloon to inflate.

Q44a. The ice - cream gained heat from the surrounding.

Q44b. He should pour hot water into the basin, and put ice cubes into metal cup P.

Q44c. Cup P loses heat to the ice cubes and contracts. Cup Q gains heat from the hot water and expands.

THE END